

TSB 21

☐ Laufschiene Deckenmontage so1

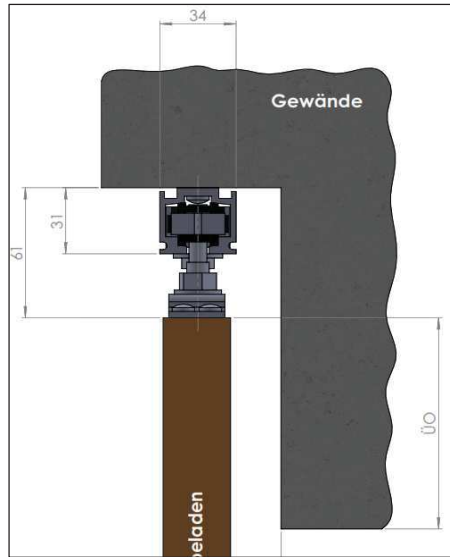

☐ Laufschiene Deckenmontage so1

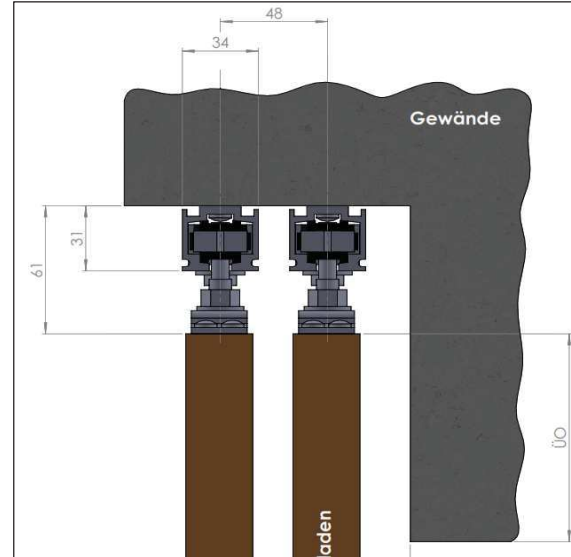

☐ Laufschiene Bügelmontage so2

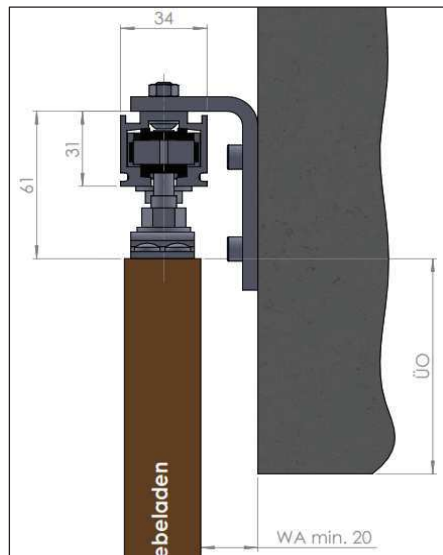

☐ Laufschiene Bügelmontage so2

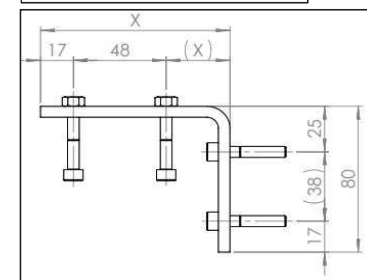
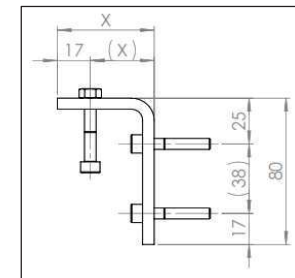
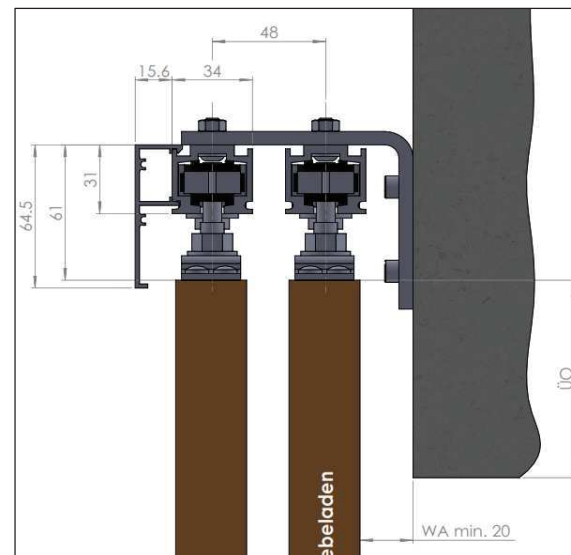

Frontfold 60 niedere Ausführung

□ Laufschiene Deckenmontage so1

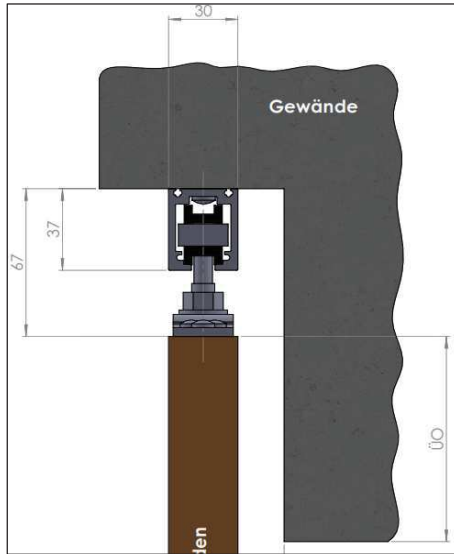

□ Laufschiene Deckenmontage so1

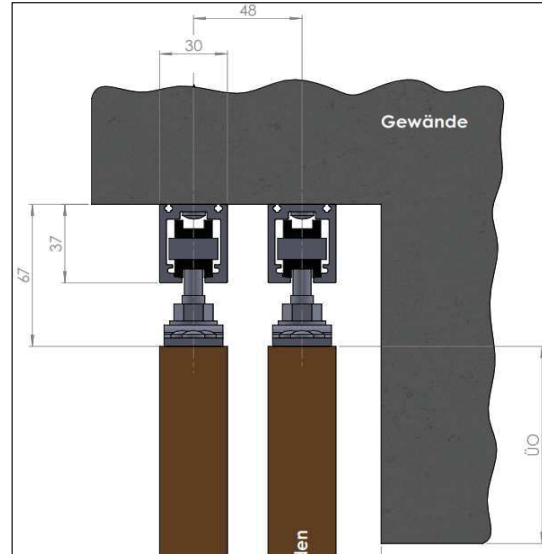

□ Laufschiene Bügelmontage so2

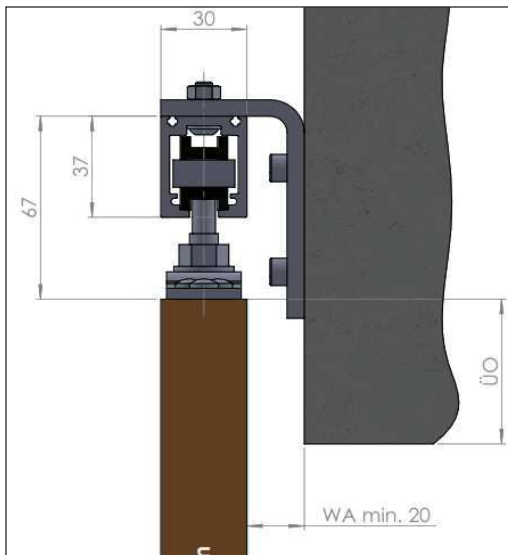

□ Laufschiene Bügelmontage so2

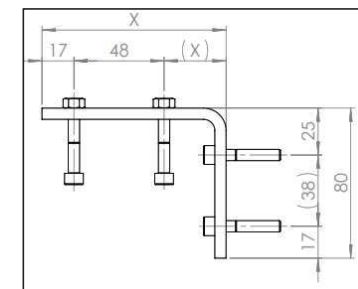
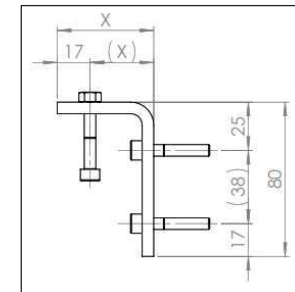
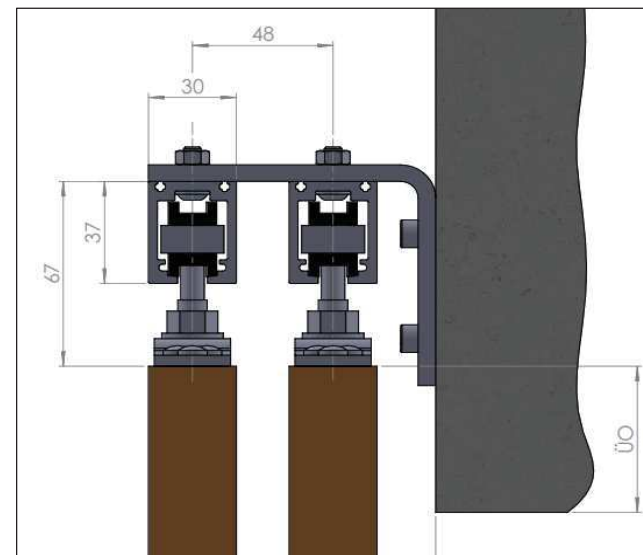

Frontfold 60 Matic (ohne Motor)

□ Laufschiene Deckenmontage so1

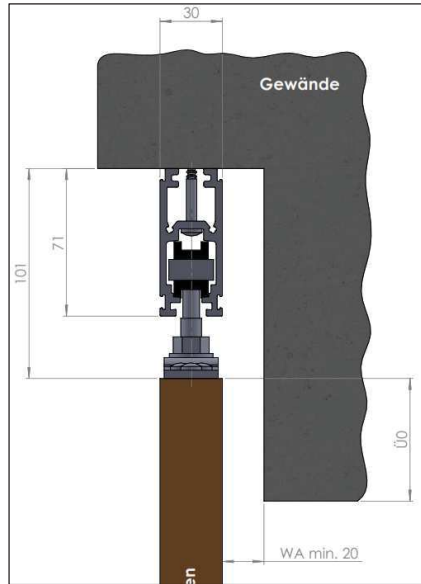

□ Laufschiene Deckenmontage so1

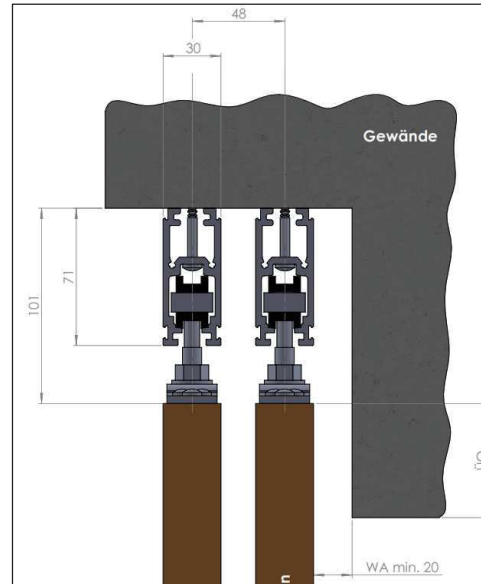

□ Laufschiene Bügelmontage so2

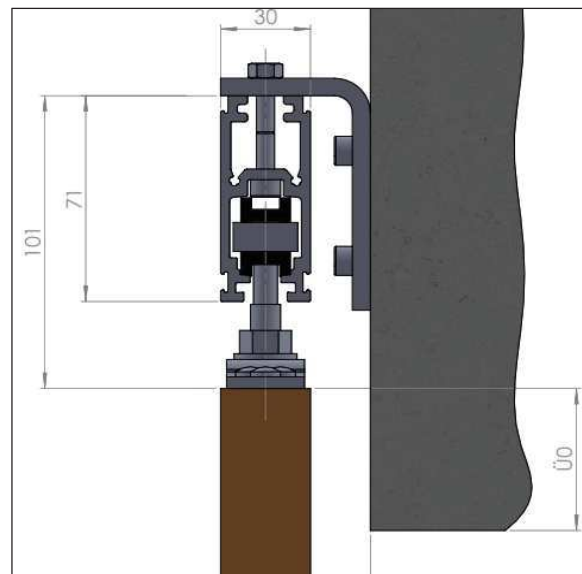

□ Laufschiene Bügelmontage so2

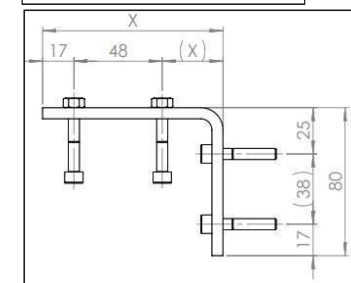
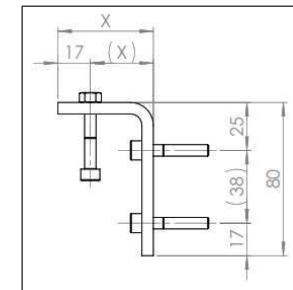
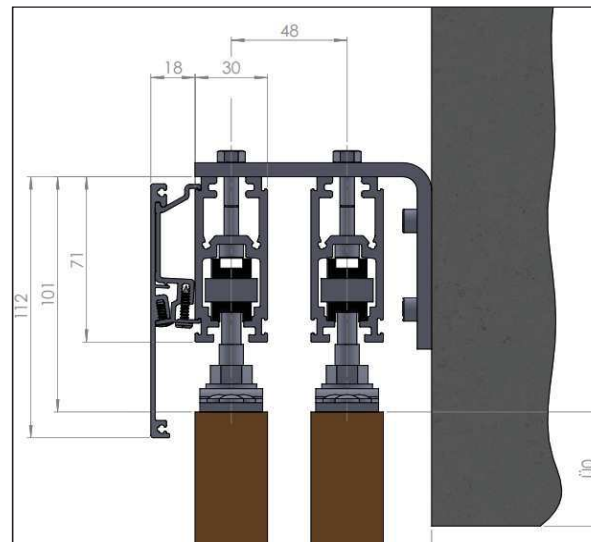

Frontfold 60 Matic (mit Motor)

☐ Laufschiene Deckenmontage so1

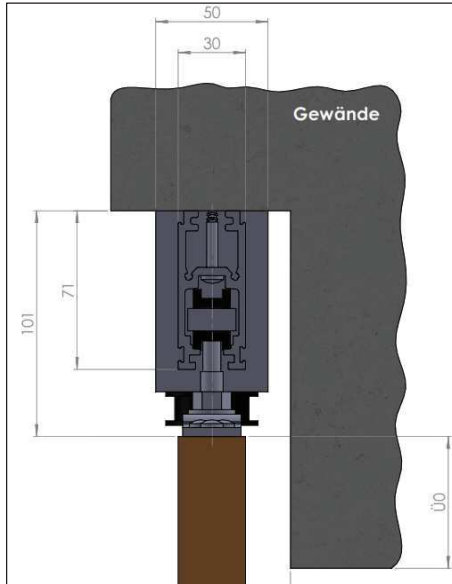

☐ Laufschiene Deckenmontage so1

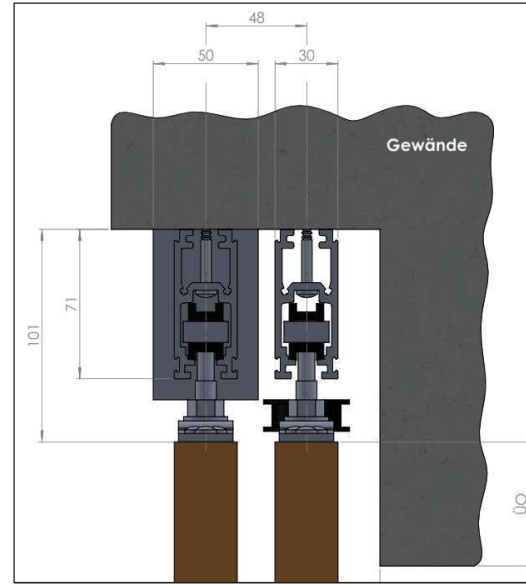

☐ Laufschiene Bügelmontage so2

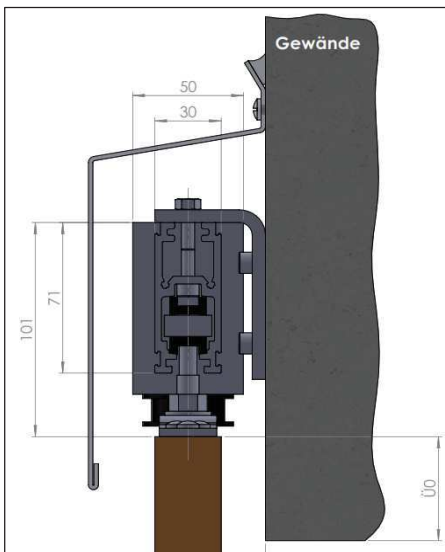

☐ Laufschiene Bügelmontage so2

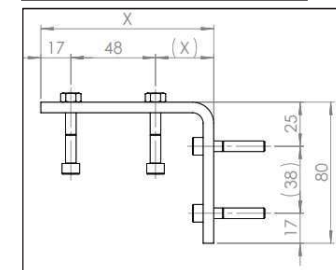
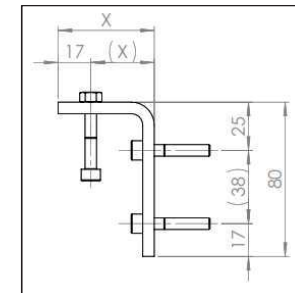
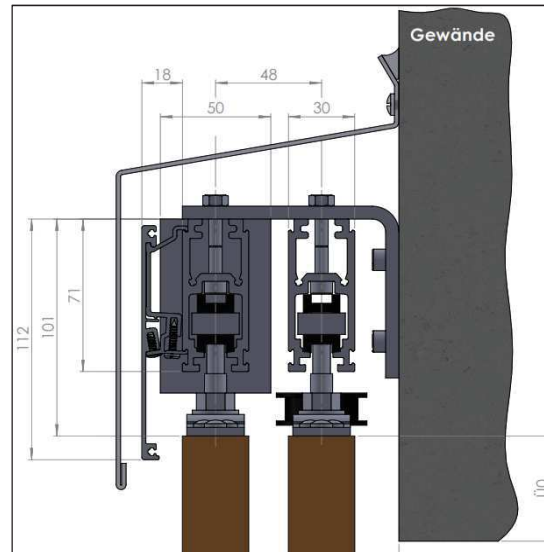

Führungsschiene SU1

□ Montagesituation SU1 H-Gleiter

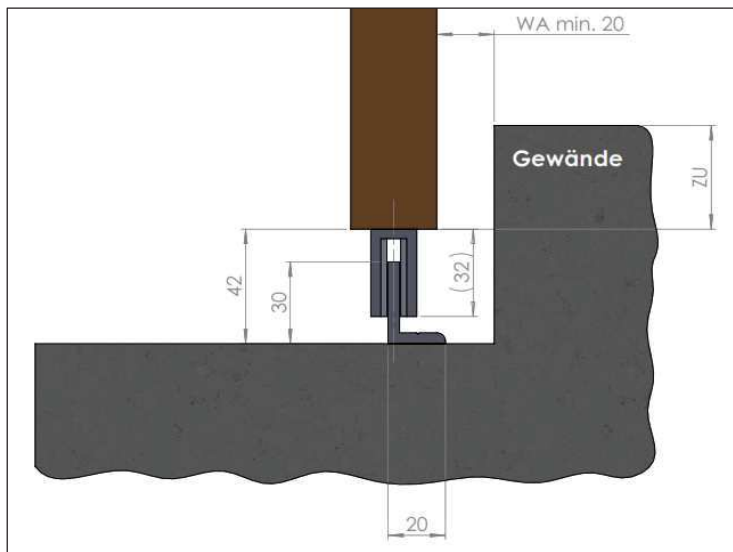

□ Montagesituation SU1 AK-Gleiter

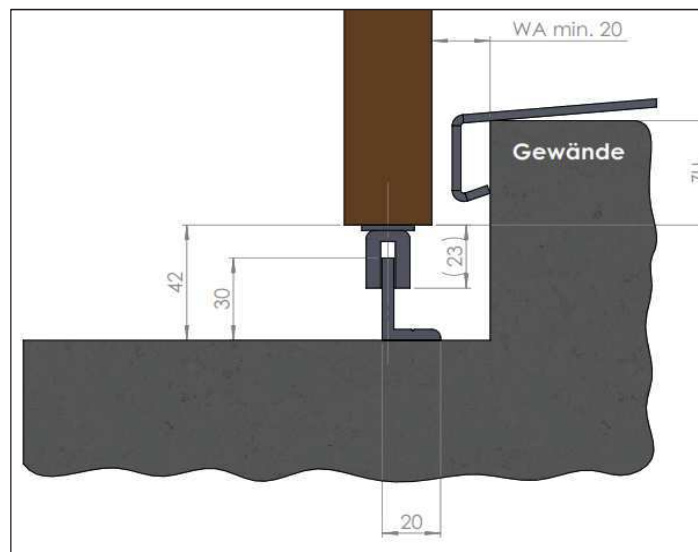

□ Montagesituation SU2 mit AK-Gleiter

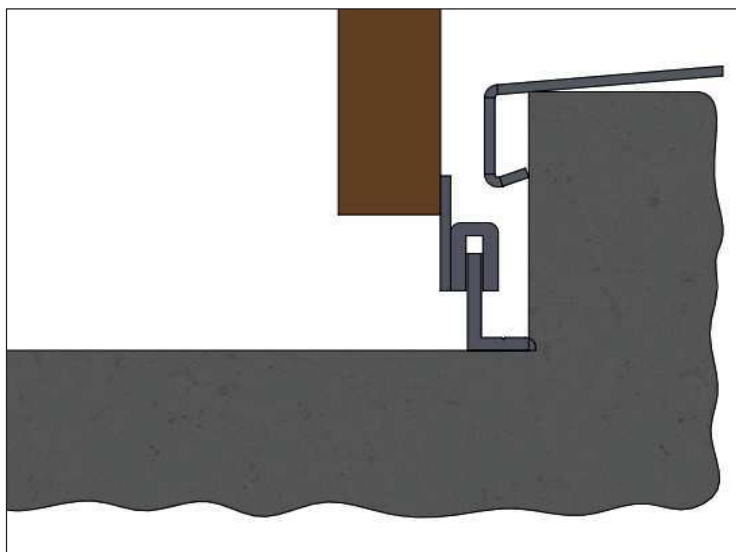

□ Montagesituation SU1 AK-Gleiter

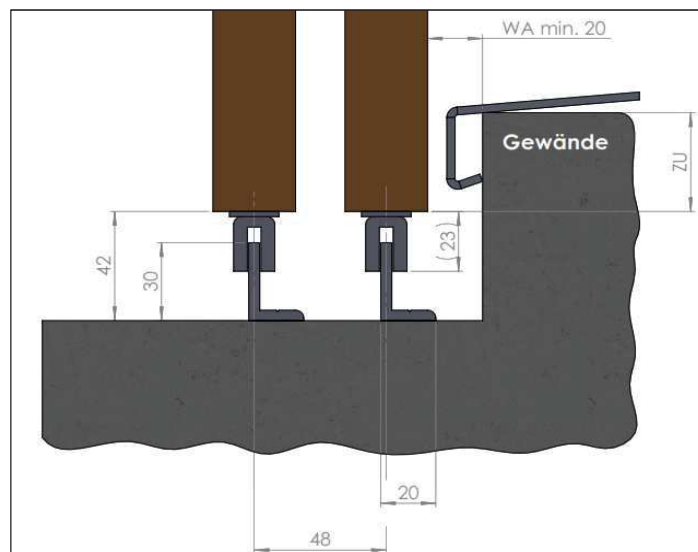

Führungsschiene SU8 50 x 4 mm / Z- Schiene

□ Montagesituation SU8 H-Gleiter

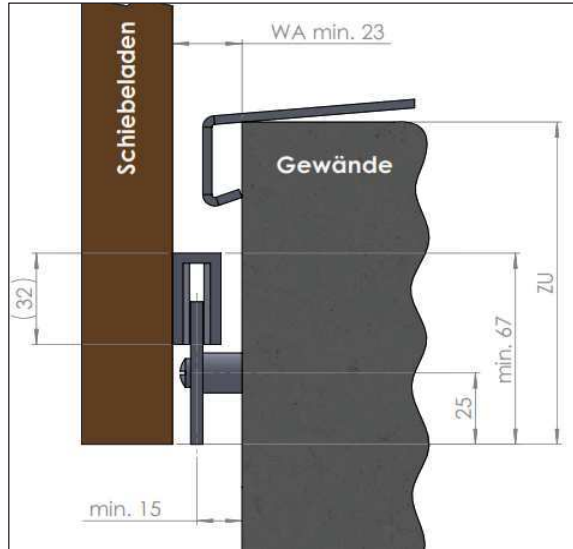

□ Montagesituation SU8 AK-Gleiter

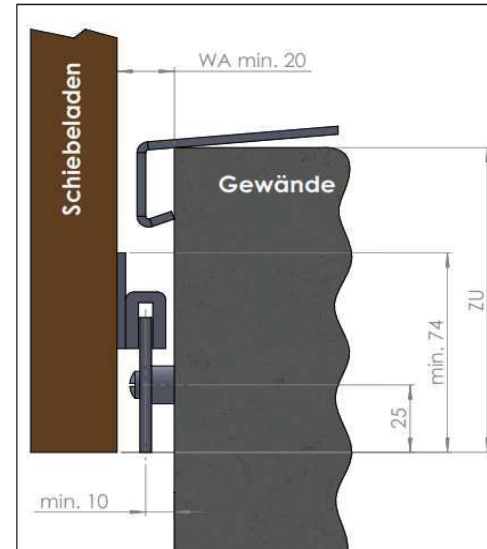

□ Montagesituation SU8 H-Gleiter



□ Montagesituation SU24 mit AK-Gleiter

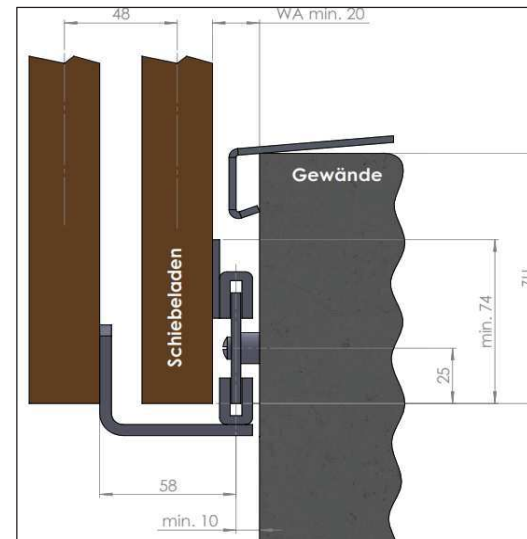

Führungsschiene SU23 / Bodenführung

□ Montagesituation SU23 AK-Gleiter

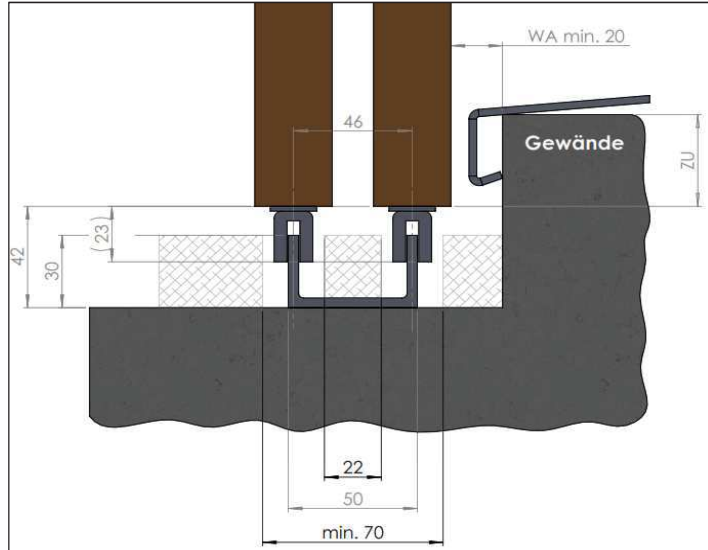

□ Montagesituation Bodenführung gross

